

MÉRETEK









MÉRET (M x SZ x Mé)	627x1120x570mm
BRUTTÓ/NETTÓ SÚLY	183/163 kg
AJTÓ MÉRETE	885x300 mm
FÜSTCSÖCSONK ÁTMÉRŐ	Ø 150-153 mm Függ leges
KÜLSŐ LEVEGŐ BEVEZET	Ø 80 mm

TULAJDONSÁGOK

ÖNTÖTTVAS RÁCS	
PANORÁMA TŰZKÉP	
ACÉL TEST	3 mm
NÉVLEGES TELJESÍTMÉNY	8,9 KW
HATÁSFOK	80,8 %
CO	0,10 %
HŐÁLLÓ FESTÉK	800°C
ELLENÁLLÓ KERÁMIA ÜVEG	750°C

PLUSZ TERMÉK

ECODESIGN 2022

-  KÜLS LEVEG BEVEZETÉS
-  VERMIKULIT BELSŐ
-  SZERIGRAFÁLT ÜVEG
-  TŰZIFA MÉRET 80 CM
-  240 m³ BEFŰTHETŐ LÉGTÉR
-  TISZTA ÜVEG RENDSZER
-  KETTŐS ÉGÉS
-  LÉGCSATORN
-  TANGENCIÁLIS VENTILÁTOR

DC-100 EcoDesign

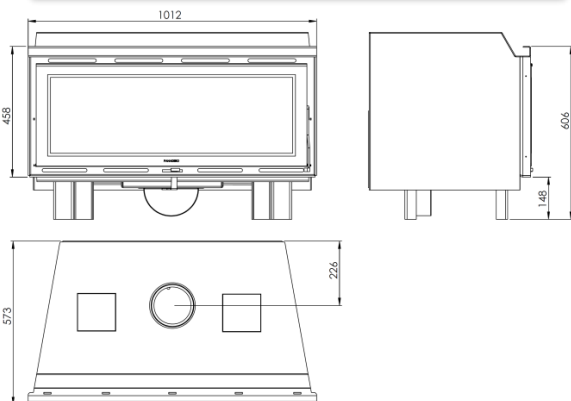
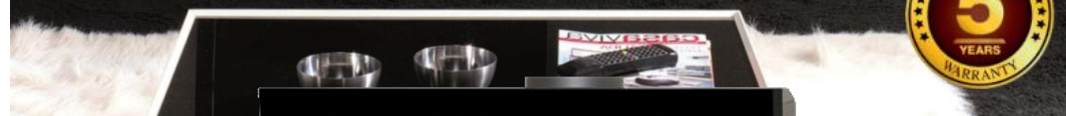

EAN 8426964249019
REF. 24901



BlmSchV2

