

## MEASURES

DIMENSIONS H x W x D	627x1120x470 mm
GROSS/NET WEIGHT	120/105 kg
FIREWOOD ENTRANCE	885x300 mm
SMOKE FLUE	Ø 150-153 mm Vertical
EXTERNAL AIR INTAKE	Ø 80 mm







## CHARACTERISTICS

CAST IRON GRILL

NOMINAL HEAT OUTPUT	5 mm
NOMINAL HEAT OUTPUT	9 KW
EFFICIENCY	80,8 %
CO EMISSIONS	0,10 %
HEAT RESISTANT PAINT	800°C
VITRO-CERAMIC GLASS RESISTANCE	750°C

## PLUS PRODUCT ECODESIGN 2022

HERMETIC

-  **EXTERNAL AIR INTAKE**
-  **VERMICULITE INSIDE**
-  **WOOD LOGS 80 CM**
-  **240 m³ HEATING VOLUME**
-  **DOUBLE COMBUSTION**
-  **AIR-WASH GLASS CLEANING SYSTEM**
-  **SERIGRAPHED GLASS**



EAN 8426964249019  
REF. PANADERO 24901

# DC-100 EcoDesign

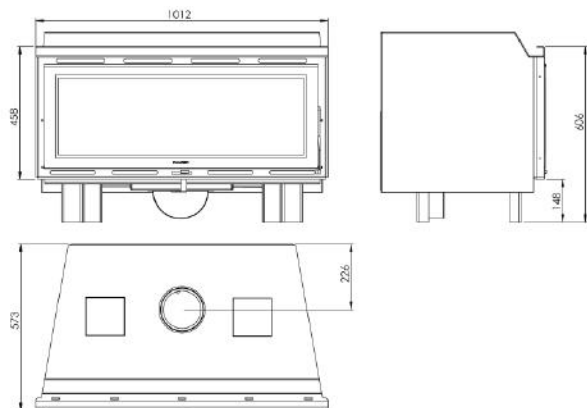
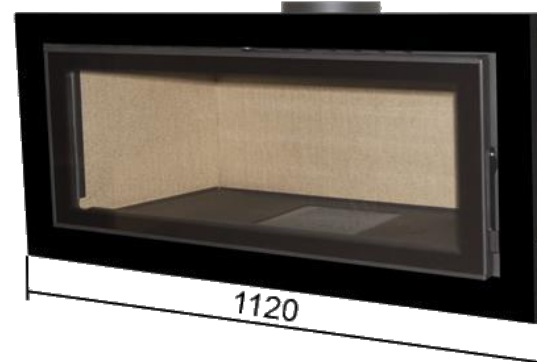
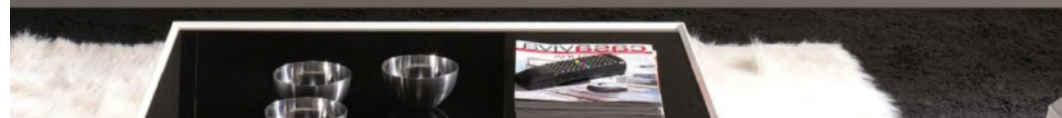

**BlmSchV2**

