

MEDIDAS

DIMENSIONES AxAxF	943x1091x465 mm
PESO BRUTO/NETO	160/151 kg
DIMENSIONES PUERTA	870x300 mm
SALIDA DE HUMOS	Ø 150-153 mm Vertical
ENTRADA DE AIRE EXTERIOR	Ø 80 mm

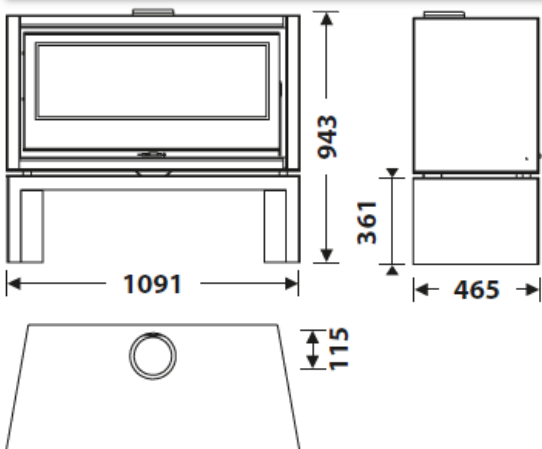







CARACTERÍSTICAS

PARRILLA DE HIERRO FUNDIDO	
VISION PANORAMICA	
DOBLE CUERPO EN CHAPA	5+3 mm
POTENCIA CALORÍFICA	8,9 KW
RENDIMIENTO	80,8 %
EMISIÓN DE CO	0,10 %
PINTURA ANTI-CALÓRICA RESISTENTE	800°C
CRISTAL VITROCERÁMICA RESISTENCIA	750°C



PLUS PRODUCTO

ECODESIGN 2022

-  TOMA DE AIRE EXTERIOR
-  HOGAR REVESTIDO EN VERMICULITA
-  PUERTA EN VIDRIO SERIGRAFIADO
-  TRONCOS HASTA 80 CM
-  VOLUMEN CALEFACCIÓN 240 m³
-  SISTEMA CRISTAL LIMPIO
-  DOBLE COMBUSTION
-  DOBLE CUERPO EN ACERO 5 + 3 MM



EAN STOVE BENCH 8426964243550
REF. STOVE BENCH 24355

EAN PANORAMIC STOVE 8426964243505
REF. PANORAMIC STOVE 24350

PANORAMIC + STOVE BENCH EcoDesign



BImSchV2

