

MEASURES

DIMENSIONS H x W x D	879x857x469 mm
GROSS/NET WEIGHT	228/195 kg
FIREWOOD ENTRANCE	620x286 mm
SMOKE FLUE	Ø 150-153 mm Top
EXTERNAL AIR INTAKE	Ø 80 mm

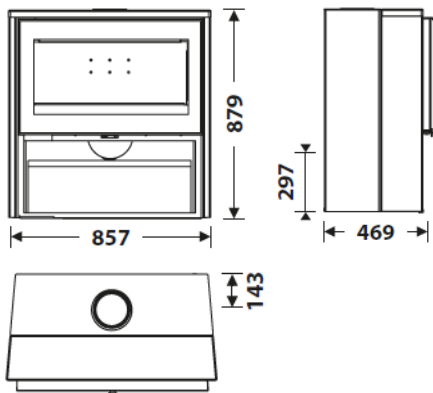









CHARACTERISTICS

CAST IRON GRILL	
PANORAMIC VISION	
STEEL BODY SHEET	5+3 mm
NOMINAL HEAT OUTPUT	7,2 KW
EFFICIENCY	78,9 %
CO EMISSIONS	0,10%
HEAT RESISTANT PAINT	800°C
CERAMIC GLASS HEAT RESISTANCE	750°C



PRODUCT PLUS

ECODESIGN 2022

-  **EXTERNAL AIR INTAKE**
-  **WHITE REFRACTORY BRICKS**
-  **WOOD LOG STORAGE**
-  **WOOD LOGS 60 CM**
-  **250 m³ HEATING VOLUME**
-  **CLEAN GLASS SYSTEM**
-  **TRIPLE COMBUSTION**
-  **DOUBLE LOCK**
-  **PRINTED GLASS**
-  **NATURAL STONE**



EAN 8426964243000
REF. 24300



BlmSchV2



FIREX EcoDesign



FIREX

