

## MEDIÇÕES E PESOS

DIMENSÕES A x L x P	879x857x469 mm
PESO BRUTO/LÍQUIDO	228/200 kg
OCO ENTRADA LENHA	620x286 mm
SAÍDA DE FUMOS	Ø 150-153 mm Vertical
ENTRADA DE AR EXTERNA	Ø 80 mm

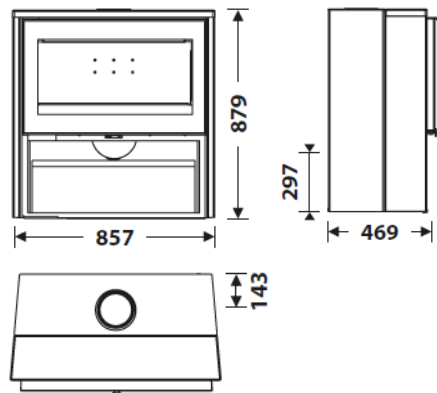









## CARACTERÍSTICAS TÉCNICAS

GRADE DE CINZAS EM FERRO FUNDIDO	
VISÃO PANORÂMICA	
CORPO EM AÇO	5+3 mm
POTÊNCIA NOMINAL	7 KW
RENDIMENTO	80,7 %
EMIÇÃO DE CO	0,10%
PINTURA RESISTENTE A ALTA TEMPERATURA	800°C
VIDRO CERÂMICO	750°C



## PLUS PRODUTO

### ECODESIGN

-  ENTRADA DE AR EXTERNA
-  REFRATÁRIO
-  TRONCOS DA LENHA ATÉ 60 CM
-  VOLUME DE AQUECIMENTO 210 m<sup>3</sup>
-  SISTEMA VIDRO LIMPO
-  PORTA COM VIDRO SERIGRAFADO
-  FECHO DUPLO
-  TRIPLA COMBUSTÃO 3
-  LENHEIRO
-  PEDRA NATURAL



EAN 8426964243000  
REF. 24300

# FIREX EcoDesign



FIREX PT



flamme  
VERTE

Le label  
du chauffage  
au bois

7 ★



TÜVRheinland®  
CERT  
ISO 9001



BlmSchV2

