

## РАЗМЕРЫ

РАЗМЕРЫ В x Ш x Г	<b>879x857x469 мм</b>
ВЕС/ЧИСТЫЙ ВЕС	<b>228/200 кг</b>
ОТСЕК ДЛЯ ДРОВ	<b>620x286 мм</b>
ДЫМОВОЙ КАНАЛ	<b>Ø 150-153 мм</b> Верхний
ВНЕШНИЙ ВОЗДУХОЗАБОРНИК	<b>Ø 80 мм</b>

## ХАРАКТЕРИСТИКИ

ЧУГУННАЯ РЕШЕТКА	
ПАНОРАМНЫЙ ОБЗОР	
СТАЛЬНОЙ КОРПУС	<b>5+3 мм</b>
НОМИНАЛЬНЫЙ ВЫХОД ТЕПЛА	<b>7 Кв</b>
ЭФФЕКТИВНОСТЬ	<b>80,7 %</b>
ВЫБРОСЫ СО	<b>0,10%</b>
ТЕРМОСТОЙКОЕ ПОКРЫТИЕ	<b>800°C</b>
ВИТРОКЕРАМИЧЕСКАЯ СТЕКЛОПРОЧНОСТЬ	<b>750°C</b>

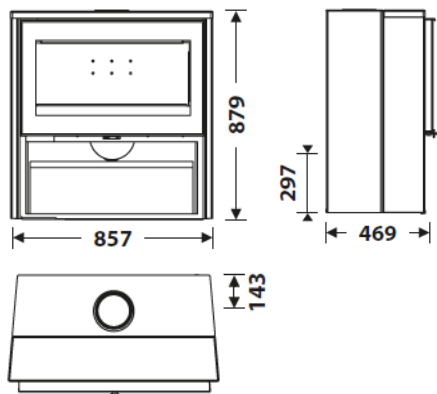

## ОСОБЕННОСТИ

### ECODESIGN

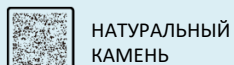
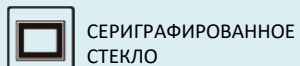
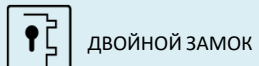
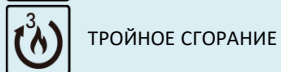
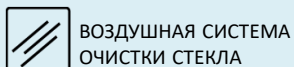
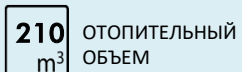
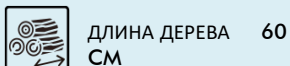
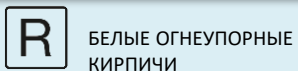
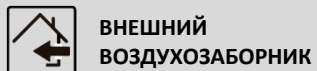

EAN 8426964243000  
REF. 24300



**BlmSchV2**



# FIREX EcoDesign



FIREX RU

