

## WYMIARY

WYS.xSZER.xGŁ.	854x796x463 mm
WAGA BRUTTO/NETTO	155/141 kg
WYMIARY DRZWICZEK	620x286 mm
WYLOT SPALIN	Ø 150-153 mm Pionowy
DOŁOT POWIETRZA Z ZEWNĄTRZ	Ø 80 mm

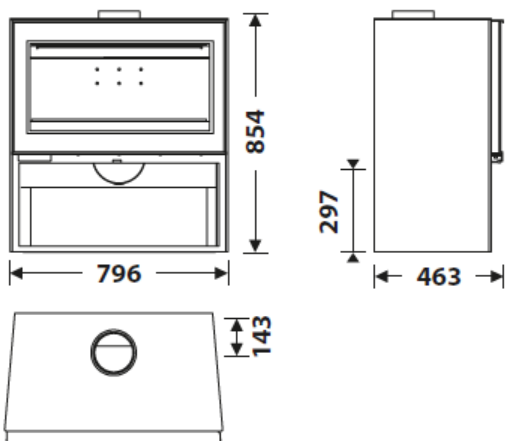







## CHARAKTERYSTYKA

RUSZT ŻELIWNY	
KORPUS ZE STALI	5 mm
MOC NOMINALNA	7,2 KW
SPRAWNOŚĆ	78,9 %
EMISJA CO	0,10 %
FARBA ŻAROODPORNĄ	800°C
SZYBA SZKLANO-CERAMICZNA	750°C



## ZALETY PRODUKTU

### ECODESIGN 2022

-  DOŁOT POWIETRZA Z ZEWNĄTRZ
-  MATERIAŁ OGNIOTRWAŁY
-  WNĘKA NA DREWNO
-  DŁUGOŚĆ POLAN DO 60 CM
-  OGRZEWANA KUBATURA 250 m³
-  SPALANIE TRÓJSTOPNIOWE
-  SYSTEM CZYSTA SZYBA
-  PODWÓJNE ZAMYKANIE
-  SZYBA Z SITODRUKIEM



EAN 8426964243109  
REF. 24310



BImSchV2



# FINLAND EcoDesign

