

## MEDIDAS

DIMENSIONES A x A x F	625x770x485 mm
PESO BRUTO/NETO	96/86 kg
DIMENSIONES PUERTA	600x300 mm
SALIDA DE HUMOS	Ø 150-153 mm Vertical
ENTRADA DE AIRE EXTERIOR	Ø 80 mm

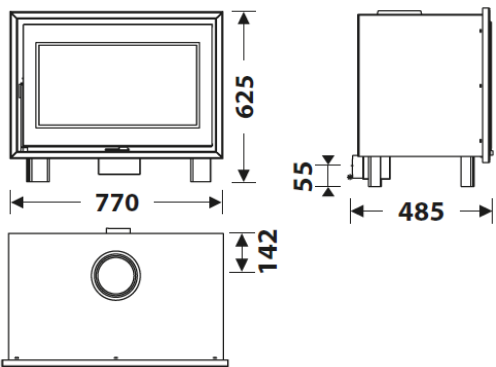





## CARACTERÍSTICAS

PARRILLA DE HIERRO FUNDIDO	
VISION PANORÁMICA	
CUERPO EN CHAPA	3 mm
POTENCIA CALORÍFICA	7 KW
RENDIMIENTO	81 %
EMISIÓN DE CO	0,10%
PINTURA ANTI-CALÓRICA RESISTENTE	800°C
CRISTAL VITROCERÁMICO RESISTENCIA	750°C



## PLUS PRODUCTO

### ECODESIGN

-  TOMA DE AIRE EXTERIOR
-  HOGAR REVESTIDO EN VERMICULITA
-  PUERTA EN VIDRIO SERIGRAFIADO
-  TRONCOS HASTA 60 CM
-  VOLUMEN DE CALEFACCIÓN 250 m³
-  SISTEMA CRISTAL LIMPIO
-  DOBLE COMBUSTIÓN



EAN 8426964247503  
REF. 24750



**BlmSchV2**



# DF-80 EcoDesign



HOGAR DF-80 ES

