

MEASURES

DIMENSIONS H x W x D	625x770x485 mm
GROSS/NET WEIGHT	128/110 kg
FIREWOOD ENTRANCE	600x300 mm
SMOKE FLUE	Ø 150-153 mm Top
EXTERNAL AIR INTAKE	Ø 80 mm

CHARACTERISTICS

CAST IRON GRILL	
PANORAMIC VISION	
STEEL BODY SHEET	5 mm
NOMINAL HEAT OUTPUT	7 KW
EFFICIENCY	81 %
CO EMISSIONS	0,10%
HEAT RESISTANT PAINT	800°C
CERAMIC GLASS HEAT RESISTANCE	750°C

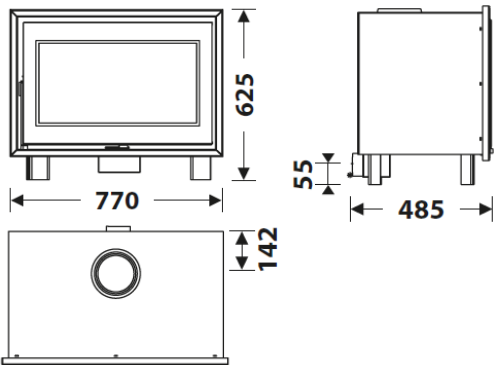

PRODUCT PLUS

ECODESIGN

- EXTERNAL AIR INTAKE
- VERMICULITE LINING
- PRINTED GLASS
- WOOD LOGS 60 CM
- 250 m³ HEATING VOLUME
- CLEAN GLASS SYSTEM
- DOUBLE COMBUSTION



EAN 8426964247503
REF. 24750



DF-80 EcoDesign

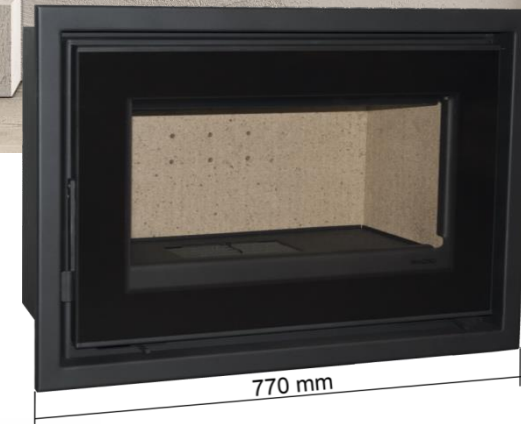

BlmSchV2

