

MEDIDAS

DIMENSIONES A x A x F	625x700x485 mm
PESO BRUTO/NETO	85/75 kg
DIMENSIONES PUERTA	550x311 mm
SALIDA DE HUMOS	Ø 150-153 mm Vertical
ENTRADA DE AIRE EXTERIOR	Ø 80 mm

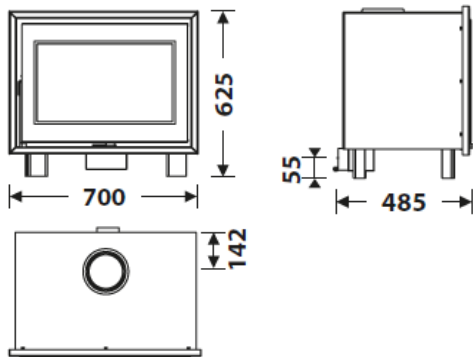





CARACTERÍSTICAS

PARRILLA DE HIERRO FUNDIDO	
VISION PANORÁMICA	
CUERPO EN ACERO	3 mm
POTENCIA CALORÍFICA	7 KW
RENDIMIENTO	81 %
EMISIÓN DE CO	0,10%
PINTURA ANTI-CALÓRICA RESISTENTE	800°C
CRISTAL VITROCERÁMICO RESISTENCIA	750°C



PLUS PRODUCTO

ECODESIGN

-  TOMA DE AIRE EXTERIOR
-  HOGAR REVESTIDO EN VERMICULITA
-  PUERTA EN VIDRIO SERIGRAFIADO
-  TRONCOS HASTA 50 CM
-  VOLUMEN DE CALEFACCIÓN 220 m³
-  SISTEMA CRISTAL LIMPIO
-  DOBLE COMBUSTIÓN



A+

EAN 8426964247008
REF. 24700



DF-70 EcoDesign



HOGAR DF-70 ES

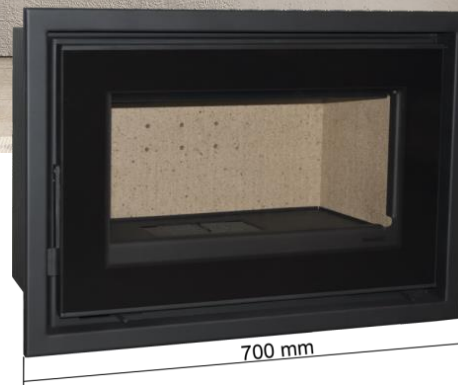

700 mm



BlmSchV2

