

MESURES

DIMENSIONS H x L x P	625x770x566 mm
POIDS BRUT/NET	106/96 kg
PORTE ENTREE BOIS	600x300 mm
SORTIE DE FUMÉES	Ø 150-153 mm Verticale
PRISE D'AIR EXTÉRIEUR	Ø 80 mm

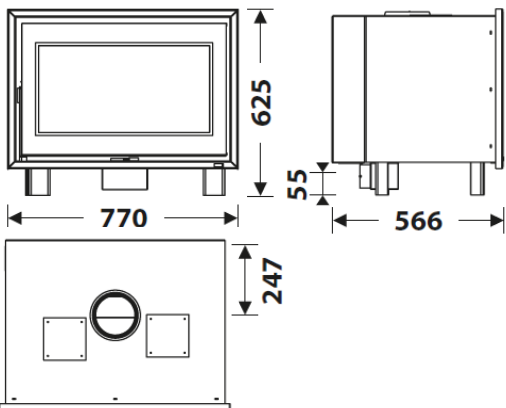







CARACTERISTIQUES

GRILLE EN FONTE	
CORPS EN ACIER DE	3 mm
PUISSANCE	7 KW
RENDEMENT	81 %
EMISSION DE CO	0,10%
PEINTURE ANTICALORIFIQUE RÉSISTANCE	800°C
VERRE VITROCÉRAMIQUE RÉSISTANCE	750°C



PLUS PRODUIT ECODESIGN

COMPATIBLE BBC
COMFORME RT 2012

-  **PRISE D'AIR
EXTÉRIEUR**
-  FOYER REVÊTU EN
VERMICULITE
-  BÛCHES DE 60 CM
-  **250**
m³ VOLUME DE
CHAUFFE
-  DOUBLE
COMBUSTION
-  SYSTÈME VITRE
PROPRE
-  PORTE EN VERRE
SERIGRAPHIÉ
-  VENTILATEUR
TANGENTIEL
-  CANALISATION
D'AIR CHAUD



A+

EAN 8426964248500
REF. 24850



flamme
VERTE Le label
du chauffage
au bois **7 ★**

DC-80 EcoDesign



DC-80 FR



BlmSchV2

