

WYMIARY

WYS.xSZER.xGŁ.	625x700x566 mm
WAGA BRUTTO/NETTO	95/85 kg
WYMIARY DRZWICZEK	500x311 mm
WYLOT SPALIN	Ø 150-153 mm Pionowy
DOŁOT POWIETRZA Z ZEWNĄTRZ	Ø 80 mm

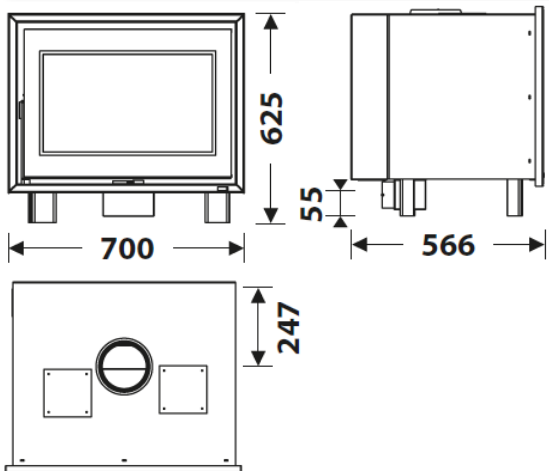







CHARAKTERYSTYKA

RUSZT ŻELIWNY	
KORPUS ZE STALI	3 mm
MOC NOMINALNA	7 KW
SPRAWNOŚĆ	81 %
EMISJA CO	0,10%
FARBA ŻAROODPORNĄ	800°C
SZYBA SZKLANO-CERAMICZNA	750°C



ZALETY PRODUKTU

ECODESIGN 2022

-  **DOŁOT POWIETRZA Z ZEWNĄTRZ**
-  WNĘTRZE WYŁOŻONE WERMIKULITEM
-  DŁUGOŚĆ POLAN DO 50 CM
-  OGRZEWANA KUBATURA
-  SPALANIE DWUSTOPNIOWE
-  SYSTEM CZYSTA SZYBA
-  SZYBA Z SITODRUKIEM
-  WENTYLATOR STYCZNY
-  SYSTEM DGP



EAN 8426964248005
REF. 24800



BImSchV2



DC-70 EcoDesign



DC-70

