

## MABE

MABE H x B x T	879x857x469 mm
GEWICHT BRUTTO/NETTO	228/200 kg
MABE FEUERRAUMTÜR	620x286 mm
DURCHMESSER DES ABGASSTUTZEN	Ø 150-153 mm Vertikal
EXTERNE LUFTZUFUHR	Ø 80 mm

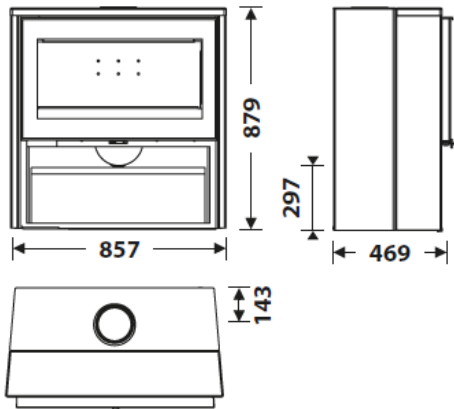





## EIGENSCHAFTEN

RÜTTELROST AUS GUSSEISEN	
BLECHGEHÄUSE	5+3 mm
NENNLEISTUNG	7 KW
WIRKUNGSGRAD	80,7 %
CO - EMISSIONEN	0,10%
HITZESCHUTZANSTRICH	800°C
GLASKERAMIKSCHEIBE HITZEBESTÄNDIG BIS	750°C



## PRODUKT PLUS

### ECODESIGN

-  **EXTERNE LUFTZUFUHR**
-  **REFRAKTÄR**
-  **SCHEITLÄNGE 60 CM**
-  **RAUMHEIZVERMÖGEN**
-  **SCHEIBENSPÜLUNG**
-  **DREIFACHVERBRENNUNG**
-  **2-PUNKT VERSCHLUSS**
-  **BEDRUCKTE GLASKERAMIK**
-  **HOLZFACH**
-  **NATURSTEIN**



EAN 8426964243000  
REF. 24300



# FIREX EcoDesign



FIREX DE



**BlmSchV2**

