

MESURES

DIMENSIONS H x W x D	625x770x566 mm
GROSS/NET WEIGHT	106/96 kg
FIREWOOD ENTRANCE	600x300 mm
SMOKE FLUE	Ø 150-153 mm Verticale
PRISE D'AIR EXTÉRIEUR	Ø 80 mm







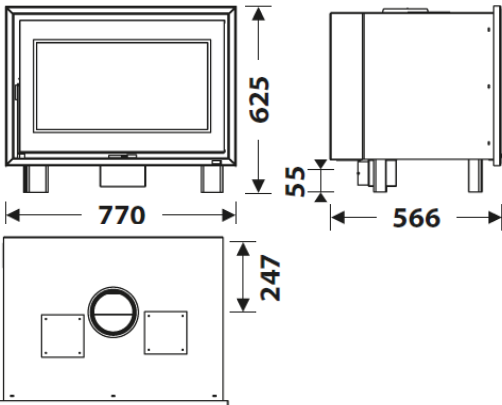

CHARACTERISTICS

CAST IRON GRILL

NOMINAL HEAT OUTPUT	5 mm
NOMINAL HEAT OUTPUT	7 KW
EFFICIENCY	81 %
CO EMISSIONS	0,10%
HEAT RESISTANT PAINT	800°C
VITRO-CERAMIC GLASS RESISTANCE	750°C



PLUS PRODUIT ECODESIGN 2022 HERMETIC

-  **EXTERNAL AIR INTAKE**
-  VERMICULITE INSIDE
-  WOOD LOGS 50 CM
-  **250 m³** HEATING VOLUME
-  **2** DOUBLE COMBUSTION
-  AIR-WASH GLASS CLEANING SYSTEM
-  SERIGRAPHED GLASS
-  TANGENTIAL VENTILATOR
-  AIR DUCTING



EAN 8426964248500
REF. PANADERO 24850

DC-80 EcoDesign



BlmSchV2

